



Suman Ramesh Tulsiani Charitable Trust's  
**SUMAN RAMESH TULSIANI TECHNICAL CAMPUS**  
**FACULTY OF ENGINEERING**

Approved by All India Council for Technical Education, Recognized by Govt. of Maharashtra  
Affiliated to Savitribai Phule Pune University and Maharashtra State Board of Technical Education  
College Code : EN6767, SPPU Code : CEGP019380, MSBTE Code : 1729

No:-SRTTC/Admn./2018-19/

Date: 13<sup>th</sup> February, 2019

**NOTICE**

All the students of degree & diploma are hereby informed that annual sports events 2018-19 will be conducted from 11/03/2019 to 13/03/2019. Interested students shall submit their individual & team entries to the respective coordinators on or before 20/02/2019.

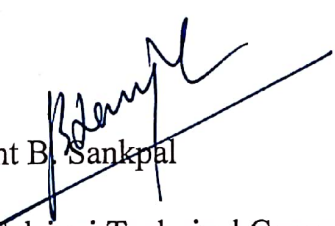
  
Prof.(Dr.) Jaywant B. Sankpal  
Principal  
Suman Ramesh Tulsiani Technical Campus  
Faculty of Engineering, Khamshet  
Pune.



C.W.C. to

1. All HODs, SRTTC, Khamshet for information and necessary action.
2. Library & System Dept.
3. All Notice Boards for student's information.

At Post Mauje Khamshet, Old Pune Mumbai Highway (NH4) Tal. Maval, Dist. Pune 410405  
Tel.: 02114-264101/106, E-Mail: info@srttc.ac.in, www.srttc.ac.in





Suman Ramesh Tulsiani Technical Campus

Faculty of Engineering

Mouje: Khamshet, Pune-Mumbai Highway(NH4), Tal: Maval, Dist: Pune. 410405

Approved By A.I.C.T.E. New Delhi, Recognized by Govt. of Maharashtra, Affiliated to University of Pune

**CO-ORDINATER DETAILS**

No.	Game	Group	Coordinator name	Mobile No.
1	Volleyball	M	Salim mulla	9764117863
2	Kabaddi	M	Shubham satpute	9503770461
3	Cricket	M	Yuvraj Borade	9561513918
4	Basketball	M	Rahul Deshmukh	7038118555
5	Kho-Kho	M/F	Suraj Game	7768084112
6	Football	M	Sandip Bhandari	8796788328
7	Doudgeball	F	Neelofar Phatan	8390958765
8	Throughball	F	Supriya Wavse	8369484653
9	Badminton	M/F	Aditya Kute	7263999321
10	Chess			
11	Carrrom			
12	Table Tennis			

*Delholare*

Mr. Ritesh Bhokare  
Physical Director,  
SRTTC, Khamshet





Suman Ramesh Tulsiani Charitable Trust's  
**SUMAN RAMESH TULSIANI TECHNICAL CAMPUS**  
**FACULTY OF ENGINEERING**

Approved by All India Council for Technical Education, Recognized by Govt. of Maharashtra  
Affiliated to Savitribai Phule Pune University and Maharashtra State Board of Technical Education  
College Code : EN6767, SPPU Code : CEGP019380, MSBTE Code : 1729

No:-SRTTC/Sports/2018-19/

Date: 25<sup>th</sup> February, 2019

**NOTICE**

All the students of Degree & Diploma are hereby informed that Annual Sports Events - 2018-19 is prepond as of Savitribai Phule Pune University In-sem Examination is scheduled and now will be arranged between 27/02/2019 to 1/03/2019.

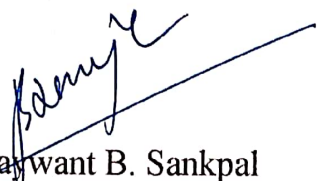
  
Prof.(Dr.) Jaywant B. Sankpal  
Principal  
Suman Ramesh Tulsiani Technical Campus  
Faculty of Engineering, Khamshet  
Pune.

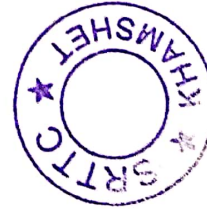

C.W.C. to

1. All HODs, SRTTC, Khamshet for information and necessary action.
2. Library & System Dept.
3. All Notice Boards for student's information.

At Post Mauje Khamshet, Old Pune Mumbai Highway (NH4) Tal. Maval, Dist. Pune 410405  
Tel.: 02114-264101/106, E-Mail: info@srttc.ac.in, www.srttc.ac.in



**SRTTC,KHAMSHET INTRA SPORTS EVENT 2019**

**SPORTS EVENT SCHEDULE**

DAY 1 - WEDNESDAY			DAY 2 - THURSDAY			DAY 3 - FRIDAY		
27-02-2019			28-02-2019			01-03-2019		
TIME	EVENT	VENUE	TIME	EVENT	VENUE	TIME	EVENT	VENUE
9.00 AM	KHO-KHO M/F	CRICKET GROUND	9.00 AM	DODGEBALL F	CRICKET GROUND	9.00 AM	NON TEACHING FACULTY V/S TEACHING FACULTY CRICKET MATCH	
11.00 AM	CRICKET M	CRICKET GROUND		KABADDI M		10.00 AM	BASKETBALL M	BASKETBALL COURT
	THROWBALL F	VOLLEYBALL COURT	FOOTBALL M	TABLE TENNIS M	GYMKHANA			
11.30 AM	VOLLEYBALL M	VOLLEYBALL COURT	12.00 PM	CRICKET M	CRICKET GROUND	12.00 PM	BADMINTON M	COMP. DEPARTMENT
11.45 AM	CARROM F	GIRLS COMMON ROOM	AS PER DRAW SCHEDULE			AS PER DRAW SCHEDULE		
12.00 PM	BADMINTON F	COMP. DEPARTMENT						
BREAK 1.00 PM TO 2.00PM			BREAK 1.00 PM TO 2.00PM			BREAK 1.00 PM TO 2.00PM		
AFTER BREAK AS PER DRAWS SCHEDULED EVENTS WILL CONTINUE ON THERE RESPECTIVE VENUE.			2.00 PM	CARROM	BOYS COMMON ROOM	AFTER BREAK AS PER DRAWS SCHEDULED EVENTS WILL CONTINUE ON THERE RESPECTIVE VENUE.		
				CHESS M				
			3.00 PM	BADMINTON	COMP. DEPARTMENT			
				M				

*R. Bhokare*  
Mr. Ritesh Bhokare  
Physical Director  
SRTTC, Khamshet

*K. J. S.*



SRTTC's Intra Sports 2K19

no - Kho Draws:

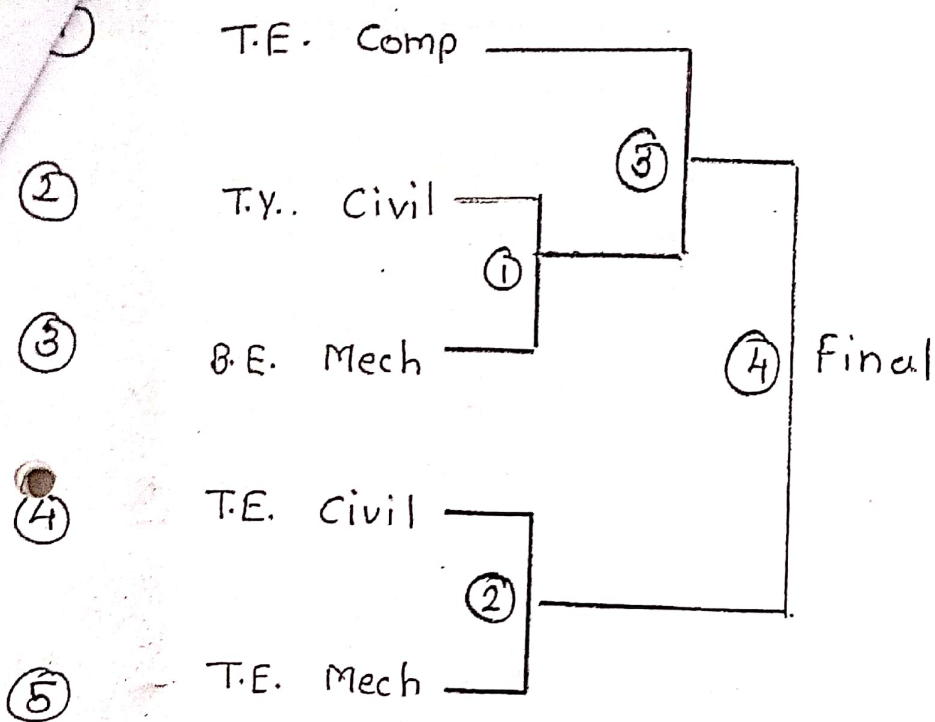

*22/10/19*  
*25/2/19*



SRTTC's Intra Sports 2k19

Cricket Draws:

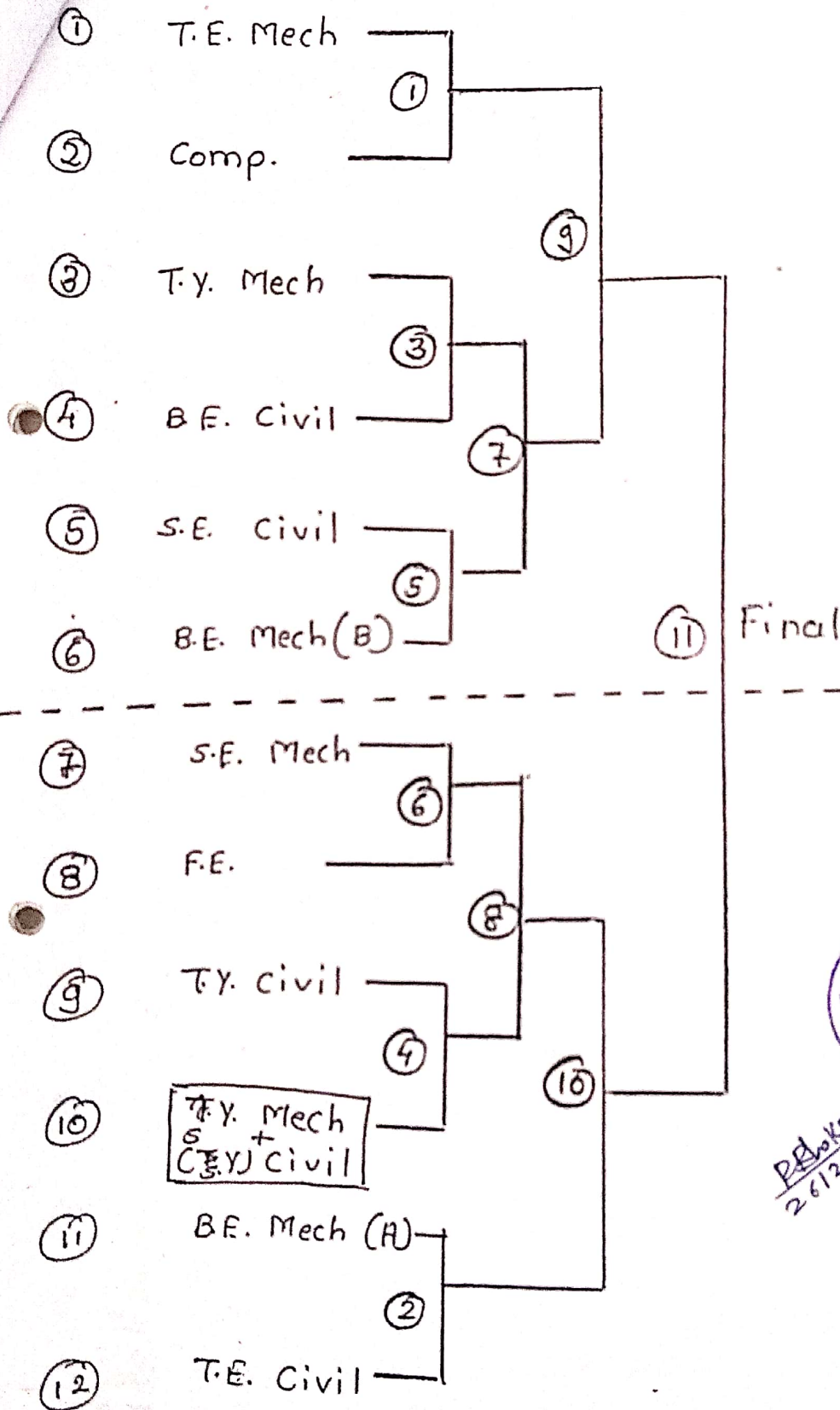

*Prakash*  
26/12/19

SRTTC's Intra Sports 2019

Meyball Draws:

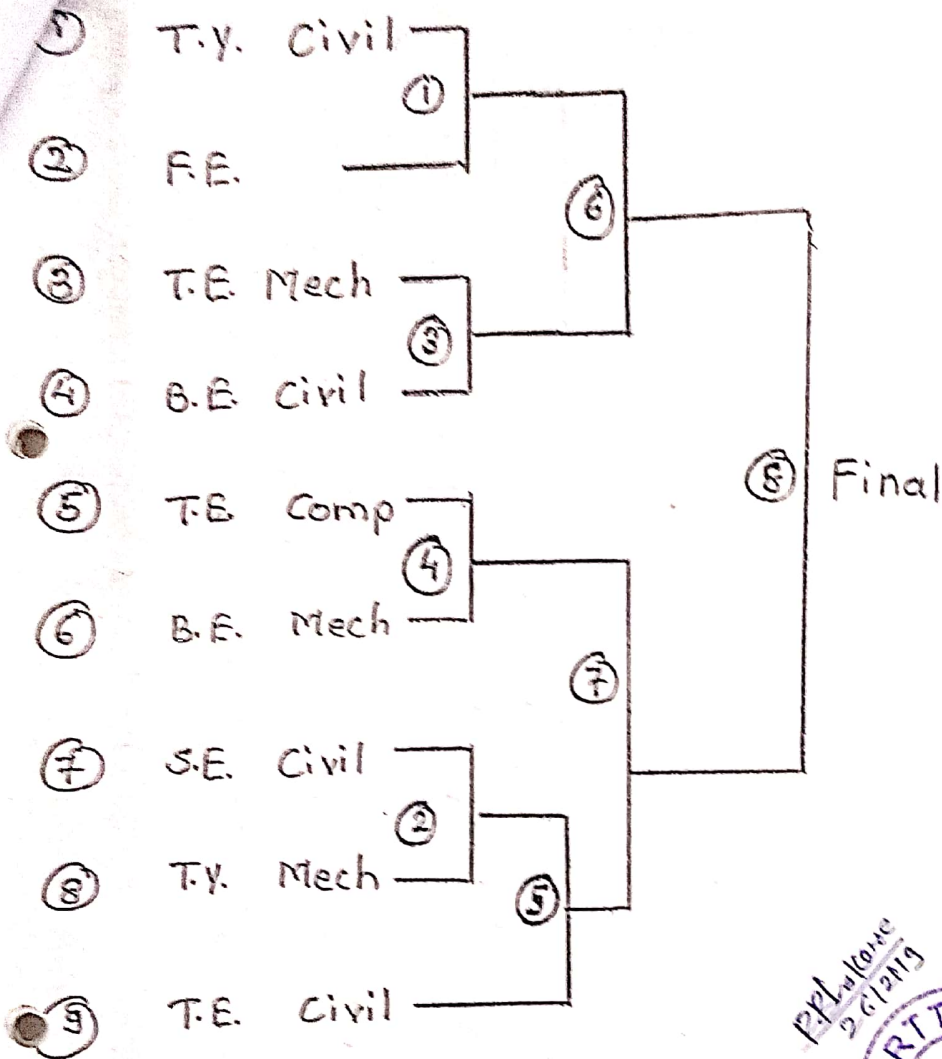

P.P.I. - Khamshet  
26/12/19

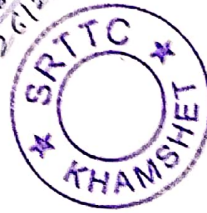

SRTTC's Intra Sports 2019

Tabaddi Draw's:

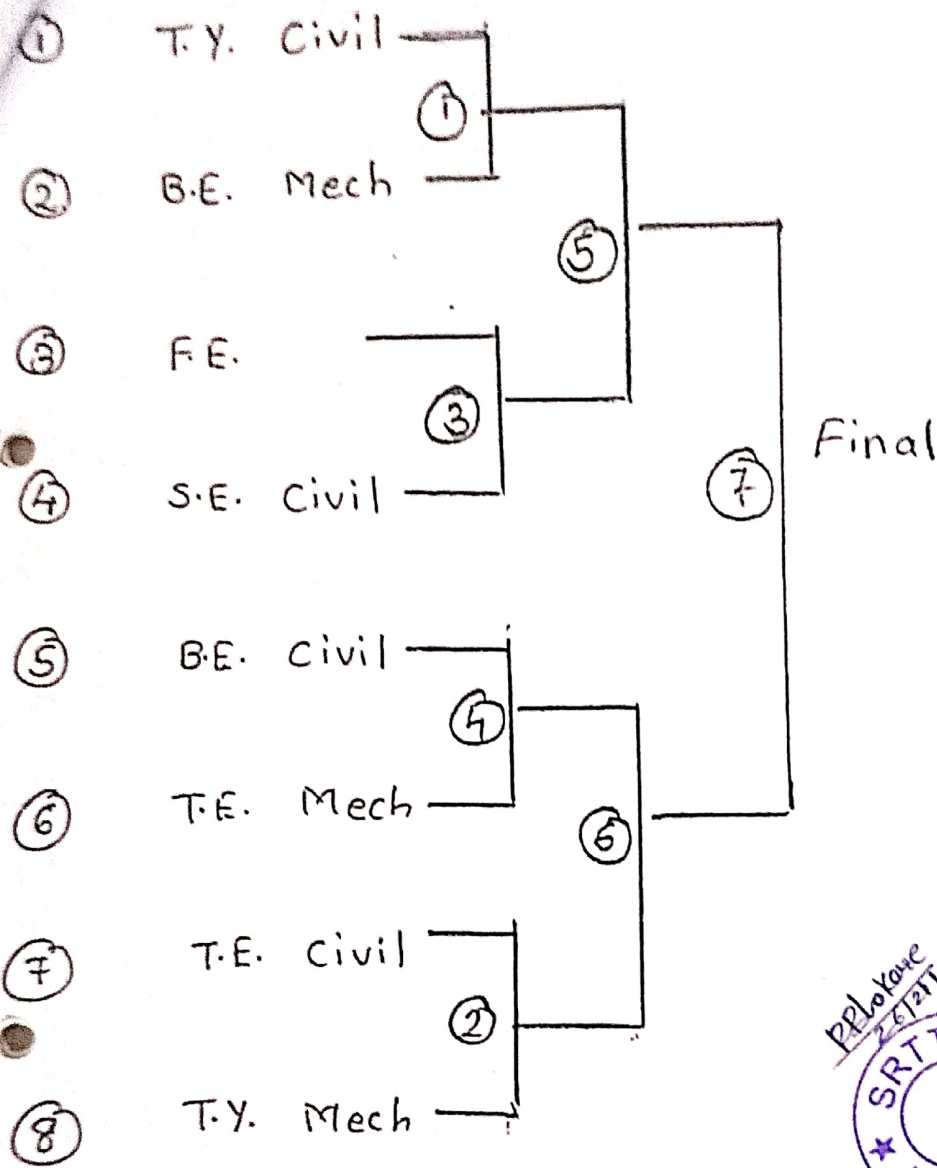

SRTTC's Intra# Sports 2019

Football Draws:-

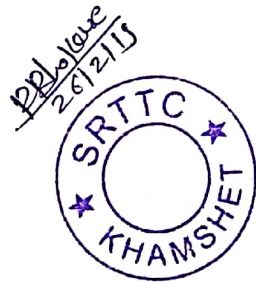
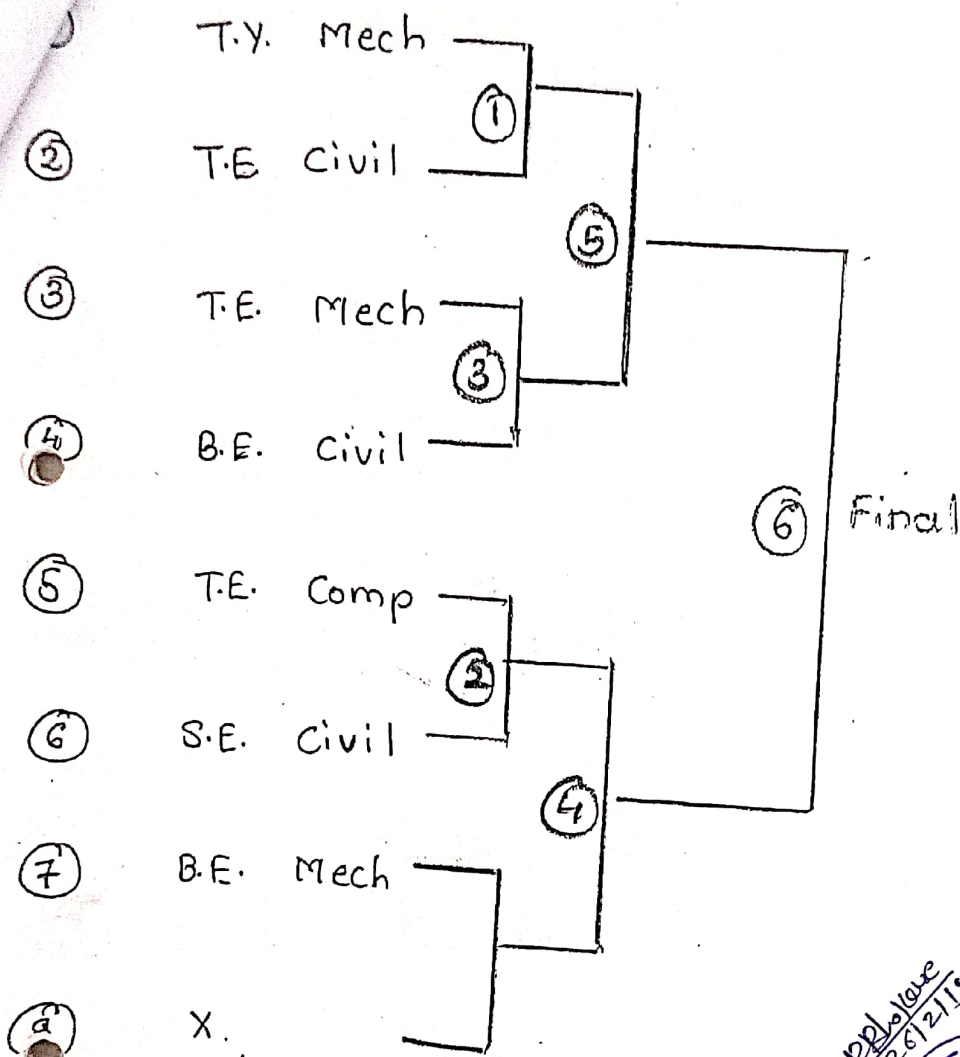

Basketball Draw's:

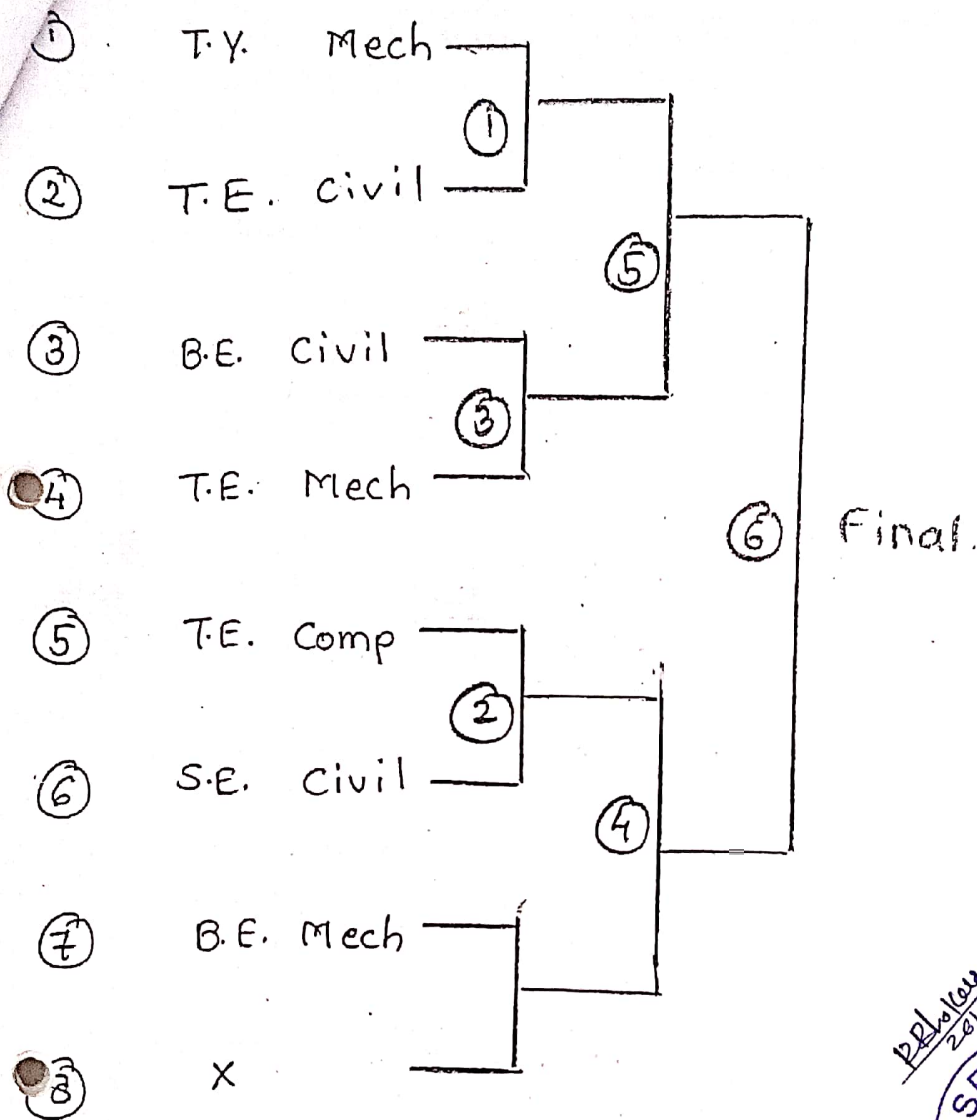



Suman Ramesh Tulsiani Technical Campus

**Faculty of Engineering**

Mauje: Khamshet, Pune-Mumbai Highway(NH4), Tal: Maval, Dist: Pune. 410405

Approved By A.I.C.T.E. New Delhi, Recognized by Govt. of Maharashtra, Affiliated to University of Pune

## Activity Report

Academic Year: 2018 - 2019

Semester: II

To,  
The Principal,  
SRTTC, Khamshet  
Pune - 410405

**Subject: Report on Intra Sports Event 2019**

Respected Sir,

SRTTC, Khamshet Department of Physical Education & sports has organized the intra sports 2019 for College **Diploma & Degree students** in between **from 27<sup>th</sup> feb 2019 to 1<sup>st</sup> march 2019**. Approximately **230 students** participated in outdoor & indoor sports events. Total no. of **12 sports event** has conducted in **3 days** schedule. For the opening of the program Honorable Trustees Mr. Shripad Kuvelkar sir & Mr. Bipin Sule sir (CEO VIT) was the chief guest. All College Faculty Member of SRTTC was present on the ground. The guest arrived at 10 am. Before the events began, the name of the event were called, the both khokho Teams were lined up. The intra sports was inaugurated by puja of new sports equipment on the ground by Dr. (Prof) Jaywant B. Sankpal (Principal SRTTC).

I hereby inform you that I have attached a few photographs, 3 days schedule sheet, Results sheet of the Events for your reference.

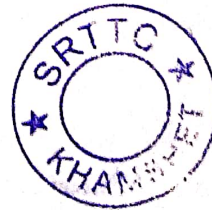

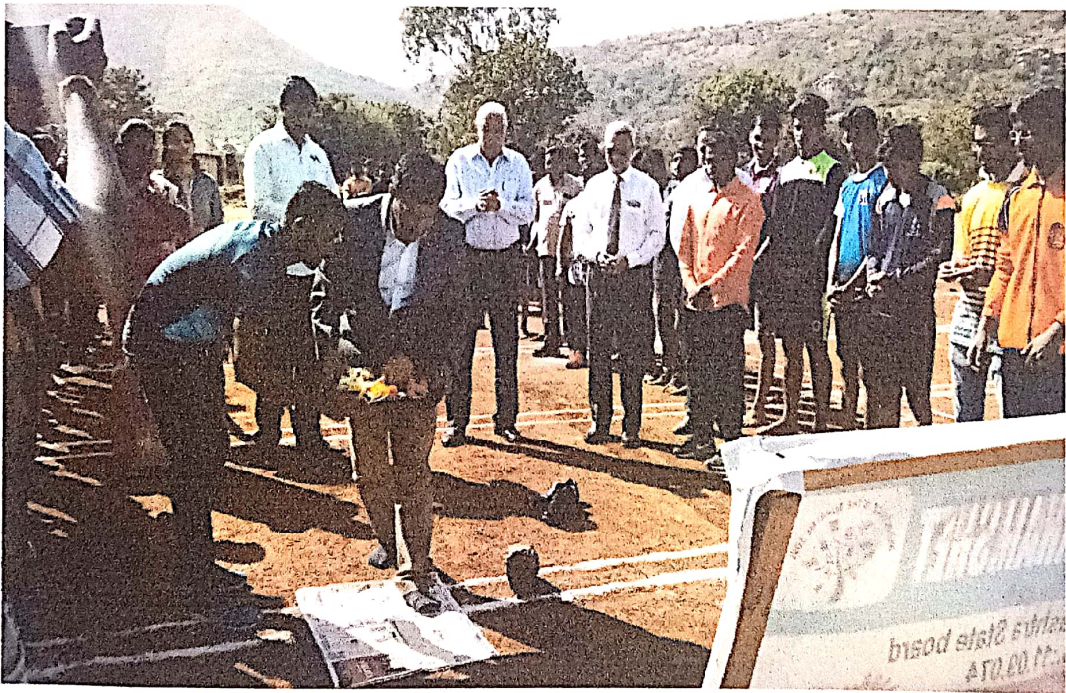

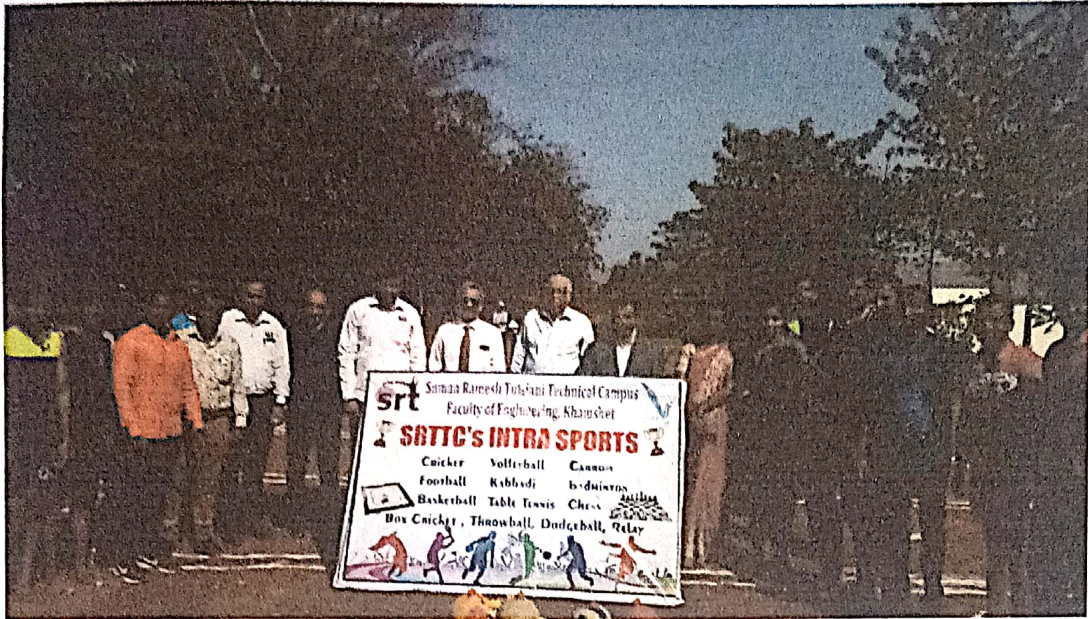

Some Photographs of the sports events



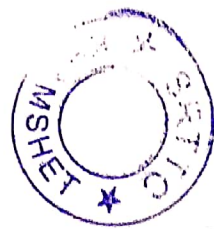

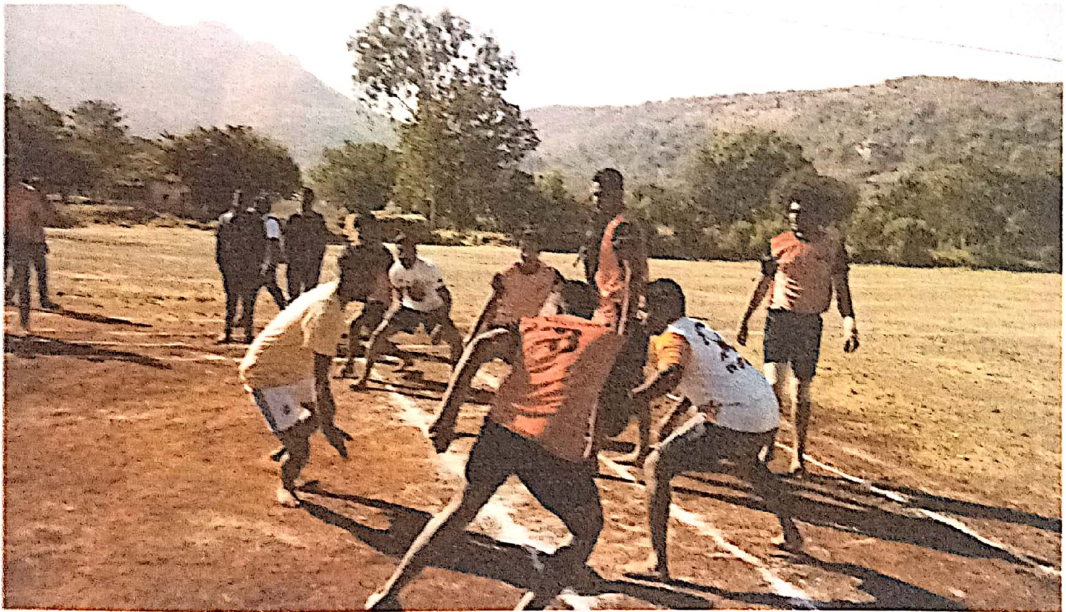

SHET

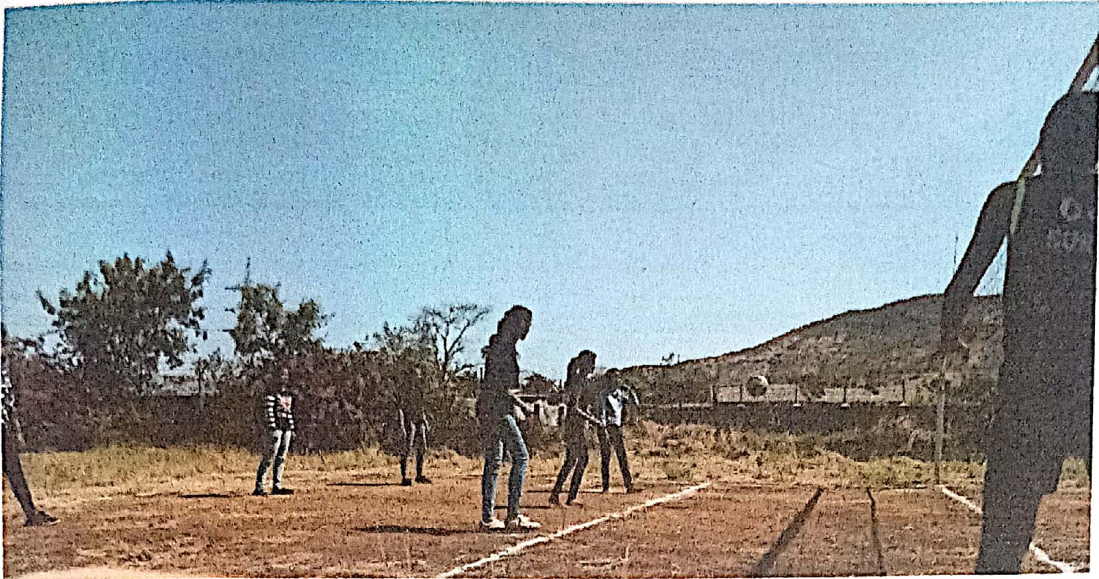

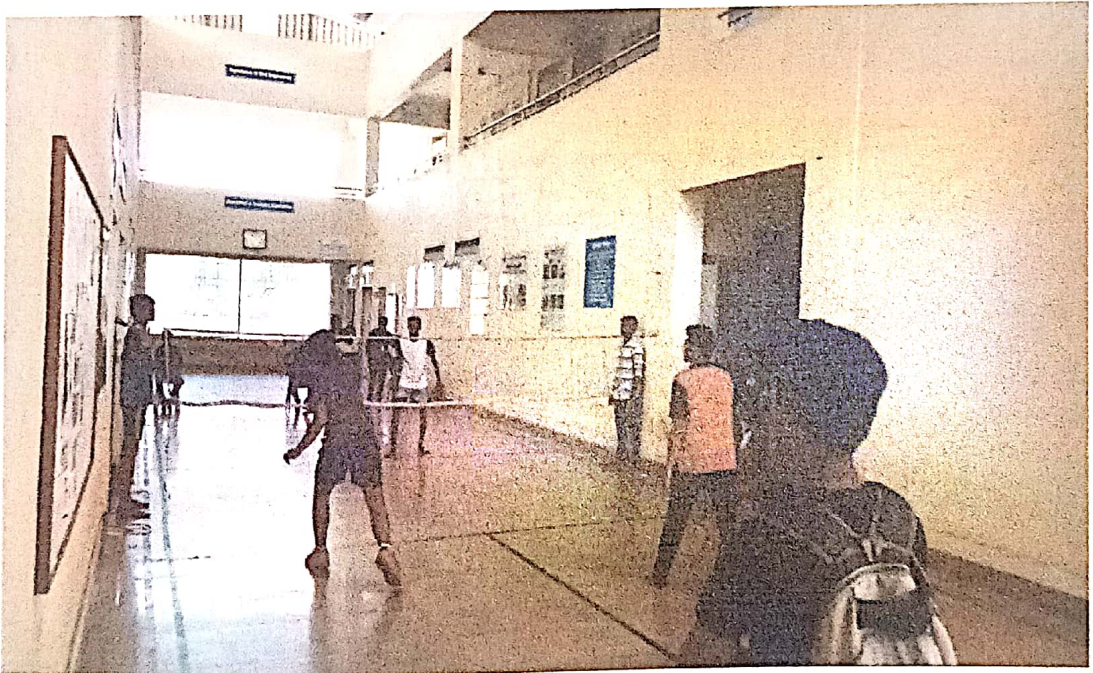

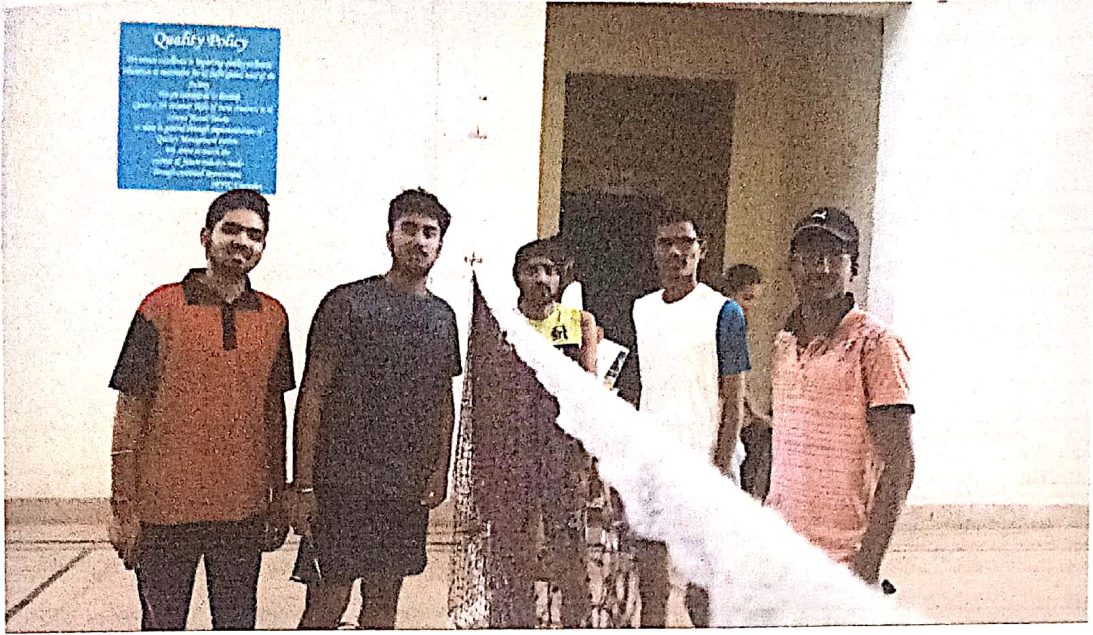

*R.Bhokare*

**Mr. Ritesh Bhokare**

Physical Director, SRTTC, Khamshet.



SRTTC, KHAMSHET INTRA SPORTS 2019 RESULTS				
No.	Game	Group	Wineer	Runner up
1	Kho - Kho	M	TE Mechanical department	Civil Department
2	kabaddi	M	TY Mechanical Department	BE Mechanical department
3	Football	M	BE Mechanical department	TE Mechanical department
4	Volleyball	M	BE Civil Department	BE Mechanical department
5	Cricket	M	TE Civil department	TY Mechanical department
6	Dodgeball	F	E&TC Department	Computer Department
7	Throwball	F	Computer Department	E&TC Department
carron				
8	Singles	F	Supriya Wavase	Reshma Horo
	Doubles	F	Neelofer Pathan	Vidhi Jain
			Supriya Wavase	Kanchan Bhagwat
	Singles	M	Ajinkya Dhanawade	Mayank Solanki
	Doubles	M	Ajinkya Dhanawade	Aditya Kute
Mayank Solanki			Rahul Deshmukh	
Chess				
9		M	Shubham Bedmutha	Suraj Gomase
Table Tennis				
10	Singles	M	Sumit Gore	Swapnil Dhakol
	Doubles	M	Omkar Vikari	Aditya Gosawi (diploma)
			Sumit Gore	Prathmesh Dhule(diploma)
Badminton				
11	Singles	F	Neelofer Pathan	Supriya Wavase
	Doubles	F	vidhi Jain	Akansha Shelar
			Supriya Wavase	Reshma Horo
	Singles	M	Aditya Kute	Vishal Shinde
	Doubles	M	Aditya Kute	Yash Nalawade
			Vishal Shinde	Shreyash Kulkarni
	Mix Doubles	FM	Shad Pansare	Aditya Kute
MF		Neelofer Pathan	vidhi Jain	

*PP/10/2019*  
 Mr. Ritesh Bhokare  
 Physical Director  
 SRTTC, Khamshet

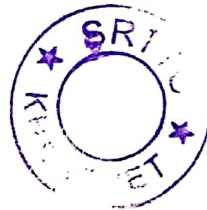

*Bhokare*



**Suman Ramesh Tulsiani Technical Campus**  
**Faculty of Engineering**

Mauje: Khamshet, Pune-Mumbai Highway (NH4), Tal: Maval, Dist: Pune-410405

Approved By AICTE, New Delhi, Recognized by Govt. of Maharashtra, Affiliated to University of Pune & MSBTE



Date - 27/02/2019			
Intra sports 2019 Final Scoresheet			
Game - Kho Kho (M)			
Team Name - TE Mechanical(Degree)		Team Name - TE Civil Degree)	
No.	Player name	No.	Player name
1	Suraj Game	1	Suraj Gomase
2	Pranav Chikhale	2	Omkar Vikari
3	Yuvraj Borude	3	Swapnil Dhakol
4	Aniket Mane	4	Shubham Satpute
5	Manoj Paware	5	Sagar Adkar
6	Shivam Shinde	6	Vikas Dhakol
7	Aksahy Sutar	7	Yogesh Dadas
8	Shubham dangre	8	Sanjay Hole
9	Bhoiraj Atole	9	Bharat pathak
10	Shubham Kurle	10	Anil Madiwal
11	Vaibhav Hadap	11	Tejas Sawant
12	Prasad Barate	12	Shubham Butala
1st Half			
TE C.	2,2,3,4,5,6,7,8,9,10,11,12,13,14,15	Score - 5	
TE M.	1,2,3,4,5,6,7,8,9,10,11,12,13,14,15	Score - 11	
2nd Half			
TE C.	1,2,3,4,5,6,7,8,9,10,11,12,13,14,15	Score - 3	
TE M.	1,2,3,4,5,6,7,8,9,10,11,12,13,14,15	Score - 0	
Result - TE Mechanical Department won by 11 - 8 points.			

*R. B. Bhokare*  
Mr. Ritesh Bhokare  
Physical Director  
SRTTC, Khamshet





**Suman Ramesh Tulsiani Technical Campus**  
**Faculty of Engineering**

Mauje: Khamshet, Pune-Mumbai Highway (NH4), Tal: Maval, Dist: Pune-410405

Approved By A.I.C.T.E., New Delhi, Recognized by Govt. of Maharashtra, Affiliated to University of Pune & MSBTE



Date - 28/02/2019			
Intra Sports 2019 Final Scoresheet			
Game - kabbaddi(M)			
Team Name - BE Mechanical(Degree)		Team Name - TY Mechanical(Diploma)	
No.	Player Name	No.	Player Name
1	Saurabh shirsat	1	Ashish Jadhav
2	Saurabh Sutar	2	Rakesh Patil
3	Besil Cheriya	3	Sandip patil
4	Pankaj Patil	4	Kunal Garud
5	Suraj Mane	5	Yash Kanade
6	Rushikesh Suryawanshi	6	Vishal Shendge
7	Pratik Shingre	7	Omkar Dalvi
8	Shivam Shinde	8	Omkar Daunde
9	Nihal Shilte	9	Manas Vidwans
10		10	
11		11	
12		12	
Running Score		Running Score	
1,2,3,4,5,6,7,8,9,10,11,12,13,14,15,16,		1,2,3,4,5,6,7,8,9,10,11,12,13,14,15,16,	
17,18,19,20,21,22,23,24,25,26,27,28,29		17,18,19,20,21,22,23,24,25,26,27,28,29	
30,31,32,33,34,35,36,37,38,39,40,		30,31,32,33,34,35,36,37,38,39,40,	
Final Score - 17		Final Score - 38	
Result - TY Mechanical Department won by 38 - 17 points.			

*P.P. Bhokare*  
Mr. Ritesh Bhokare  
Physical Director  
SRTTC, Khamshet





**Suman Ramesh Tulsiani Technical Campus**  
**Faculty of Engineering**

Mauje: Khamshet, Pune-Mumbai Highway (NH4), Tal: Maval, Dist: Pune-410405

Approved By AICTE, New Delhi. Recognized by Govt. of Maharashtra. Affiliated to University of Pune & MSBTE



Date - 28/02/2019

Intra Sports 2019 Final Scoresheet			
Game - Football(M)			
Team Name - BE Mechanical(Degree)		Team Name - TE Mechanical(Degree)	
No.	Player name	No.	Player name
1	Sandip Bhandari	1	Sohail Shaikh
2	Rahul Deshmukh	2	Duvendu Roy
3	Shubham Pimplekar	3	Pranav Chikhale
4	Anish Barse	4	YuvRaj Borude
5	Sanket Maske	5	Aniket Mane
6	Sagar Khairnar	6	Pranav Yavle
7	Abhishek	7	Rohit Khilari
8	Shyam Shinde	8	Suraj Gomase
9	Anup Sharma	9	Sanket Shinde
10	Ajinkya Dhanwade	10	Manoj Pawar
Final Score 4 - 1			
Result - BE Mechanical Department won by 4 - 1 goal.			

*P. P. Bhokare*

Mr. Ritesh Bhokare  
Physical Director  
SRTTC, Khamshet





**Suman Ramesh Tulsiani Technical Campus**  
**Faculty of Engineering**

Mauje: Khamshet, Pune-Mumbai Highway (NH4), Tal: Maval, Dist: Pune-410405

Approved By AICTE, New Delhi, Recognized by Govt. of Maharashtra, Affiliated to University of Pune & MSBTE



Date - 28/02/2019

Intra Sports 2019 Final Scoresheet			
Game - Volleyball(M)			
Team Name - BE Mechanical(Degree)		Team Name - BE Civil(Degree)	
No.	Player name	No.	Player name
1	Rahul Deshmukh	1	Shubham Satpute
2	Sandeep Bhandari	2	Omkar Vikari
3	Ashraf Khan	3	Rakesh Acharya
4	Swarrp patil	4	Sagar Adkar
5	Parag Tambake	5	Yogesh Dadas
6	Sandip Walunj	6	Amit Bhadesiya
7	Pankaj Sawant	7	Shoyeb Khan
8	Besil Cheriya	8	Sandip Shirsat
9	Sumit Gore	9	Mayur Shelhankar
10	Mayank solanki	10	Salim Mulla
11	Ajinkya Dhanawade	11	Prasad kadu
12	Akash Bhanusghare	12	Shubham Bedmutha
1st set			
1,2,3,4,5,6,7,8,9,10,11,12,13,14,15		1,2,3,4,5,6,7,8,9,10,11,12,13,14,15	
Score - 12		Score - 15	
2nd set			
1,2,3,4,5,6,7,8,9,10,11,12,13,14,15		1,2,3,4,5,6,7,8,9,10,11,12,13,14,15	
Score - 11		Score - 15	
3rd set			
1,2,3,4,5,6,7,8,9,10,11,12,13,14,15		1,2,3,4,5,6,7,8,9,10,11,12,13,14,15	
Score - 0		Score - 0	
Result - BE Civil Department won by 2 - 0 set.			

*R. R. Bhokare*  
Mr. Ritesh Bhokare  
Physical Director  
SRTTC, Khamshet





**Suman Ramesh Tulsiani Technical Campus**  
**Faculty of Engineering**

Mauje: Khamshet, Pune-Mumbai Highway (NH4), Tal: Maval, Dist: Pune-410405

Approved By A.I.C.T.E. New Delhi, Recognized by Govt. of Maharashtra, Affiliated to University of Pune & MSBTE



Date - 01/03/2019

Intra sports 2019 Final Scoresheet			
Game - Cricket (M)			
Team Name - TY Mechanical(Diploma)		Team Name - TE Civil(Degree)	
No.	Player name	No.	Player name
1	Manas Vidwans	1	Sunil Bodke
2	Mustaqim Mulla	2	Akshay Konbhar
3	Omkar Daunde	3	Amit Bhadesiya
4	Omkar Dalvi	4	Bharat Patak
5	Aniket Vanjari	5	Menul Shah
6	Yash Kanade	6	sumit Bhanusghare
7	Vishal Shendge	7	Anil Madiwad
8	Ashish Jadhav	8	Umesh Goje
9	Aditya Kadam	9	Omkar Vikari
10	Sandip Patil	10	Suraj Gomase
11	Akash kank	11	Vikas Dhakol
12	Rakesh Patil	12	Kunal Mali
13	Jinesh Raju	13	Suraj Dighe
14	Manish Dalvi	14	Uddnav Patange
15	Kunal Garud	15	Kedar Deshpande
16		16	
1st innngs - TE Civil Department			
Over	1,2,3,4,5		
Wicket	1,2,3,4,5,6,7,8,9,10		
Run	1,2,3,4,5,6,7,8,9,10,11,12,13,14,15,16,17,18,19,20,21,22,23,24,25,26,27,28,29,30,31,32,33,34,35,36,37,38,39,40,41,42,43,44,45,46,47,48,49,50		
Total Score	- 44		
2nd innngs - TY Mechanical Department			
Over	1,2,3,4,5		
Wicket	1,2,3,4,5,6,7,8,9,10		
Run	1,2,3,4,5,6,7,8,9,10,11,12,13,14,15,16,17,18,19,20,21,22,23,24,25,26,27,28,29,30,31,32,33,34,35,36,37,38,39,40,41,42,43,44,45,46,47,48,49,50		
Total Score	- 35		
Result	- TE Civil Department won by 9 Runs.		

*PPBhokare*  
Mr. Ritesh Bhokare  
Physical Director  
SRTTC, Khamshet

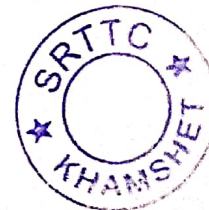



**Suman Ramesh Tulsiani Technical Campus**  
**Faculty of Engineering**

Mauje: Khamshet, Pune-Mumbai Highway (NH4), Tal: Maval, Dist: Pune-410405

Approved By A.I.C.T.E. New Delhi, Recognized by Govt. of Maharashtra. Affiliated to University of Pune & MSBTE



Date - 28/02/2019

Intra Sports 2019 Final Scoresheet			
Game - Doudgeball(F)			
Team Name - E & TC Department		Team Name - Computer Department	
No.	Player name	No.	Player name
1	Akshada Joshi	✓ 1	Supriya Wavase
2	sakshi Wagare	2	vidhi jain
3	Sayali jadhav	3	Neelofer Pathan
4	kanchan Bhagwat	4	Reshma haro
5	Aishwarya Raj	5	Akshada shelar
6	Bhakti Wamne	6	Priyanka Mahtre
1st Half Score - 3		1st Half Score - 6	
2nd Half score - 4		2nd Half score - 3	
Total Score - 7		Total Score - 9	
Result - E & TC Department won by 9 - 7 Points.			

*R. Bhokare*

Mr. Ritesh Bhokare  
Physical Director  
SRTTC, Khamshet





**Suman Ramesh Tulsiani Technical Campus**  
**Faculty of Engineering**

Mauje: Khamshet, Pune-Mumbai Highway (NH4), Tal: Maval, Dist: Pune-410405

Approved By A.I.C.T.E. New Delhi, Recognized by Govt. of Maharashtra, Affiliated to University of Pune & MSBTE



Date - 27/02/2019			
Intra sports 2019 Final scoresheet			
Game - Throwball(F)			
Team Name - Computer Department		Team Name - E & TC Department	
No.	Player name	No.	Player name
1	Neelofar Pathan	1	Supriya Wavase
2	Kanchan Bhagwat	2	Sayali Baritkar
3	Sakshi Wagare	3	Vidhi jain
4	Sayali Jadhav	4	Iavina Ruzario
5	Akshada joshi	5	Ankita More
6	Aishwarya Raj	6	Reshma Horo
1st Half Score - 8		1st Half Score - 5	
2nd Half score - 6		2nd Half score - 5	
Total Score - 14		Total Score - 10	
Result - Computer Department won by 14 - 10 Points.			

*PPJ Wavase*  
Mr. Ritesh Bhokare  
Physical Director  
SRTTC, Khamshet





**Suman Ramesh Tulsiani Technical Campus**  
**Faculty of Engineering**

Mauje: Khamshet, Pune-Mumbai Highway (NH4), Tal: Maval, Dist: Pune-410405

Approved By A.I.C.T.E. New Delhi, Recognized by Govt. of Maharashtra, Affiliated to University of Pune & MSBTE



Date - 28/02/2019

Intra Sports 2019 Final Scoresheet			
Game - Basketball(M)			
Team Name - BE Mechanical(Degree)		Team Name - BE Civil(Degree)	
No.	Player name	No.	Player name
1	Rahul Deshmukh	1	Shoyab khan
2	Prasad Barathe	2	Adeel Sayyed
3	Shashank Ghaige	3	Poornesh Paliwala
4	Yuvraj Burude	4	Piyush Gaddawal
5	Sandip Bhandari	5	Abhijit Patil
6	Ajinkya Dhanawade	6	
7	Shubham Bhosale	7	
8	Vishal Shinde	8	
1st Half			
1,2,3,4,5,6,7,8,9,10,11,12,13,14,15		1,2,3,4,5,6,7,8,9,10,11,12,13,14,15	
Score - 04		Score - 02	
2nd Half			
1,2,3,4,5,6,7,8,9,10,11,12,13,14,15		1,2,3,4,5,6,7,8,9,10,11,12,13,14,15	
Score - 06		Score - 02	
Final Score - 10		Final Score - 02	
Result - BE Mechanical Department won by 10 - 02 points.			

*P.P. Bhokare*

Mr. Ritesh Bhokare  
Physical Director  
SRTTC, Khamshet



Suman Ramesh Tulsiani Technical Campus

Faculty of Engineering

Maine: Khamshet, Pune-Mumbai Highway(NH4), Tal.Maval, Dist: Pune- 410405

Approved By A.I.C.T.E. New Delhi, Recognized by Govt. of Maharashtra, Affiliated to University of Pune

RANK  
FIELD VI

## NOTICE

Date: 14/01/2019

This is to inform you that the students of SRTTC will be visiting **SHREE SHIV CHHATRAPATI KRIDA SANKUL,BALEWADI,PUNE** on 17/01/2019 as Pune city is hosting **KHELO INDIA 2019**.The mentioned visit has been arranged by Department of Physical Education & Sports of SRTTC. All the interested students are kindly requested to report to the physical director Mr.Ritesh Bhokare for registration **before 12pm on 16/01/2019**.

Contact No. of Mr.Ritesh Bhokare : 9657141628/8669756856

Dr.Jaywant Sankpal

Principal

Srttc,Khamshet



सावित्रीबाई फुले पुणे विद्यापीठ  
(पुणेचे पुणे विद्यापीठ)



क्रीडा व शारीरिक शिक्षण मंडळ

आयुकाजवळ, गणेशखिड, पुणे - ४११००६

दूरध्यानी क्र. ०२०-२५६०११४३, २५६०११४२, टेलिफॅक्स ०२०-२५६१७५११

संदर्भ: विक्रीम/३/१०६९

दिनांक: १० जानेवारी, २०१९

प्रति,

मा. प्राचार्य / मा. संचालक,  
सावित्रीबाई फुले पुणे विद्यापीठ संलग्न महाविद्यालये  
व मान्यताप्राप्त संस्था

विषय: "खेलो इंडिया युथ गेम्स - २०१९"...

महोदय / महोदया,

आगामी ऑलिम्पिक व आशियाई स्पर्धांच्या तयारीच्या दृष्टीने गुणवंत व उदयोनमुख खेळाडू निवडून त्यांना तंत्रशुद्ध प्रशिक्षण व अर्थसहाय्य देणे, खेळासाठी पूरक वातावरण निर्माण करून सांघिक भावना निर्माण करणे, नेतृत्व गुणांचा विकास करणे तसेच खेळ हे सर्वांगीण विकासासाठी महत्त्वपूर्ण वाच असून आगामी काळात देश खेळामध्ये महाशक्ती निर्माण द्यावी हा प्रमुख उद्देश ठेवून केंद्र व राज्य शासनाच्या संयुक्त विद्यमाने खेलो इंडिया युथ गेम्स, २०१९ या शिवछत्रपती क्रीडा संकुल, म्हाळुंगे, बालेवाडी, पुणे येथे दि. ०९ ते २० जानेवारी, २०१९ या कालावधीत आयोजित करण्यात आल्या आहेत.

खेलो इंडिया क्रीडा स्पर्धेत १८ खेळांच्या स्पर्धा होणार असून स्पर्धेमध्ये देशभरातील १७ वर्षाखालील व २१ वर्षाखालील मुले व मुली या गटात सुमारे १०,००० खेळाडू सहभागी होणार आहेत. एवढ्या मोठ्या प्रमाणात सदर स्पर्धा या बालेवाडी, पुणे येथे होत असल्याने त्या पाहण्याची सुवर्णसंधी असणार आहे.

तरी उपरोक्त कालावधीत आपल्या महाविद्यालयातील खेळाडू, विद्यार्थी व विद्यार्थिनी यांना सदर स्पर्धा दाखविण्याचे नियोजन महाविद्यालयीन स्तरावर करावे व ही सुवर्णसंधी त्यांना उपलब्ध करावी, ही विनंती. तसेच सदरच्या स्पर्धांचे थेट प्रक्षेपण स्टार स्पोर्ट्स (Star Sports) या वाहिनीवर सुद्धा दाखविण्यात येणार आहे.

शिवछत्रपती क्रीडा संकुल, म्हाळुंगे, बालेवाडी, पुणे येथे भेटीच्या सहकार्यासाठी खालील क्रमांकावर संपर्क साधावा.

- |                                      |                                      |
|--------------------------------------|--------------------------------------|
| ✂ डॉ. अभिजित कदम :- ९६८९८२७०३८       | ✂ डॉ. अय्याज शेख :- ९४२२५१७८०९       |
| ✂ डॉ. दादासाहेब ढेंगळे :- ७५०७७०१७२७ | ✂ प्रा. शिरीष मोरे :- ९५४५४५५५१०     |
|                                      | ✂ प्रा. अनिरुद्ध शर्मा :- ७७०९९९९९९७ |

कळाचे,

आपला,

S K S H A I

प्रा. (डॉ.) दिपक माने,  
संचालक, क्रीडा व शारीरिक शिक्षण मंडळ,  
अधिष्ठाता, आंतर-विद्याशाखीय अभ्यास विद्याशाखा

on  
PK  
14-1-19.



Suman Ramesh Tulsiani Technical Campus

**Faculty of Engineering**

Mauje: Khamshet, Pune-Mumbai Highway(NH4), Tal:Maal, Dist: Pune- 410405

Approved By A.I.C.T.E. New Delhi, Recognized by Govt. of Maharashtra, Affiliated to University of Pune

## Activity Report

Academic Year: 2018 - 2019

Semester: II

**Subject: Khelo India 2019 Field Visit Report of “Shree shiv chhatrapati krida sankul,Balewadi,Pune ” organized on Thursday,17th Jan, 2019.**

Respected Sir,

Department of physical Education & sports of SRTTC Khamshet had organized Khelo India 2019 Field Visit to Shree Shiv Chhatrapati Krida sankul ,Balewadi,Pune on 17<sup>th</sup> Jan 2019. Sixty Eight (68) students were registered the Field visit from our College, out of which Sixty (60) were present on the day of visit. Students got an opportunity to witness live Basketball match, Volley ball match, Boxing, Stadium.

I hereby inform you that I have attached the Attendance Sheet of students and a few photographs for your reference. Kindly go through it.



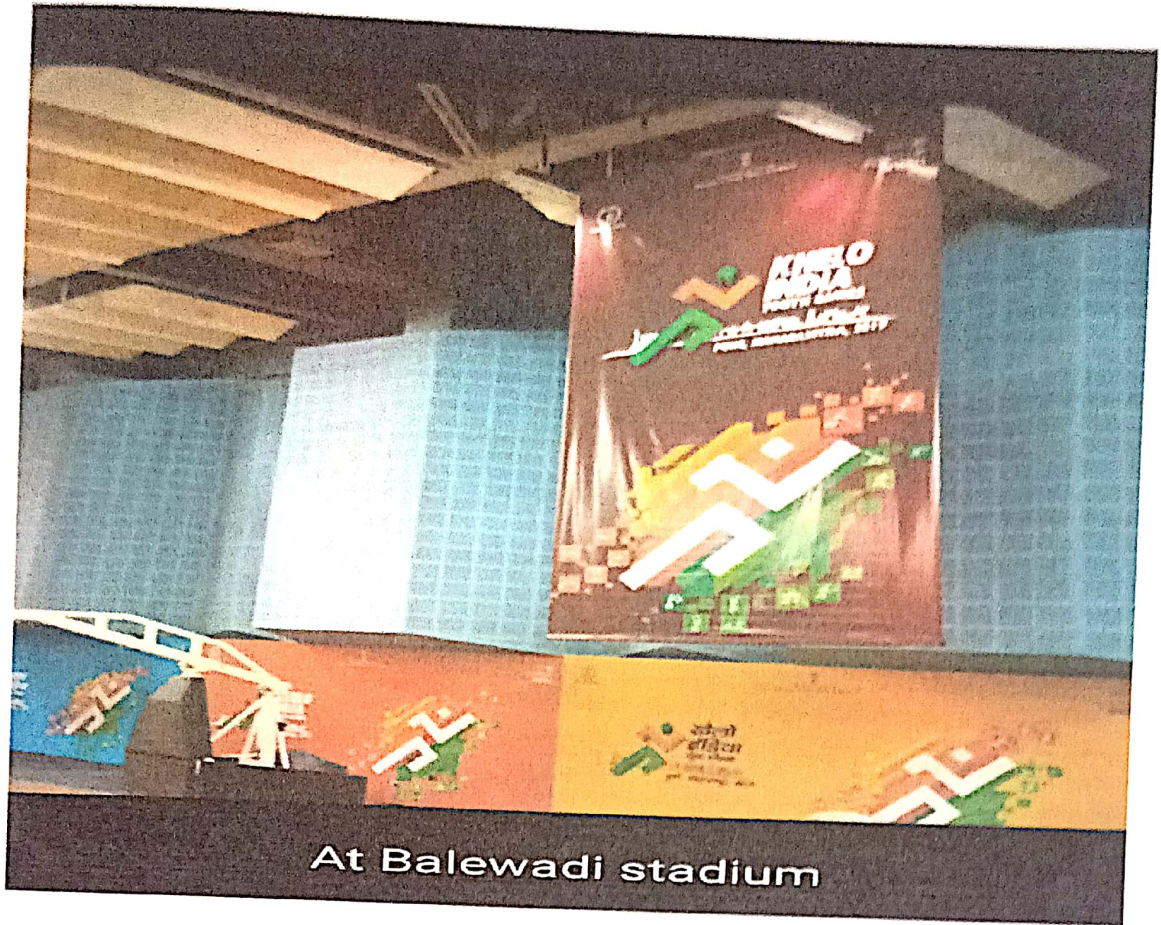

At Balewadi stadium



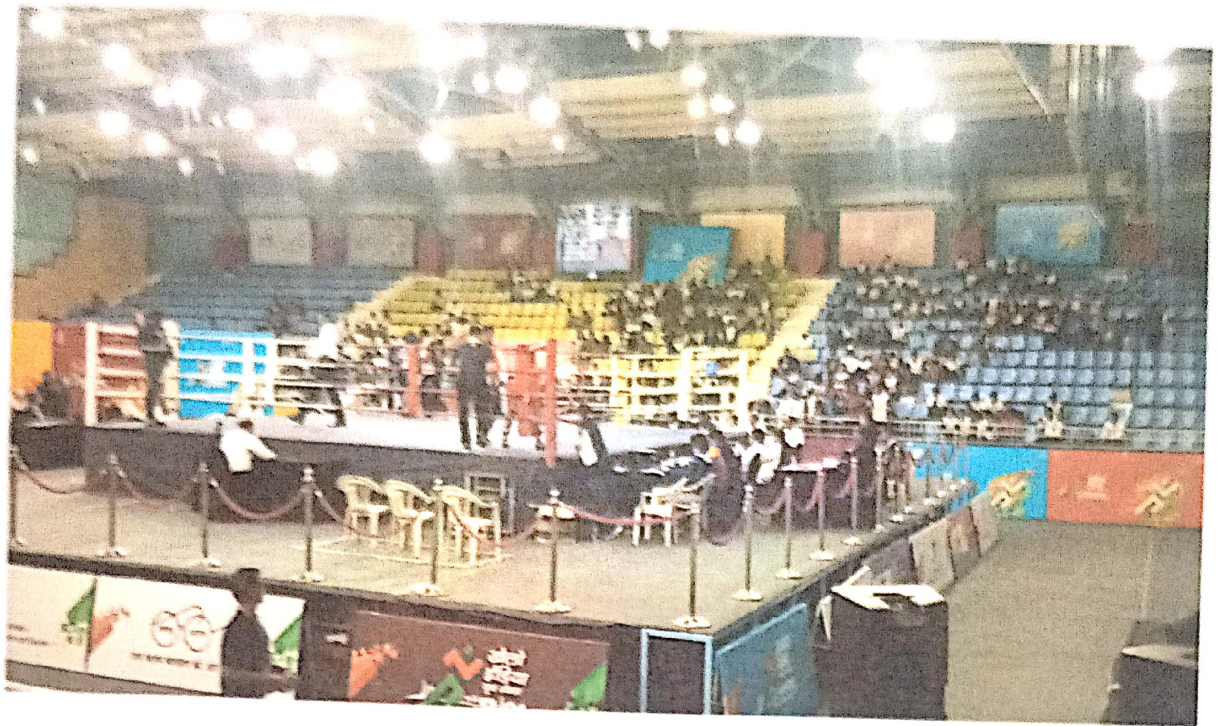

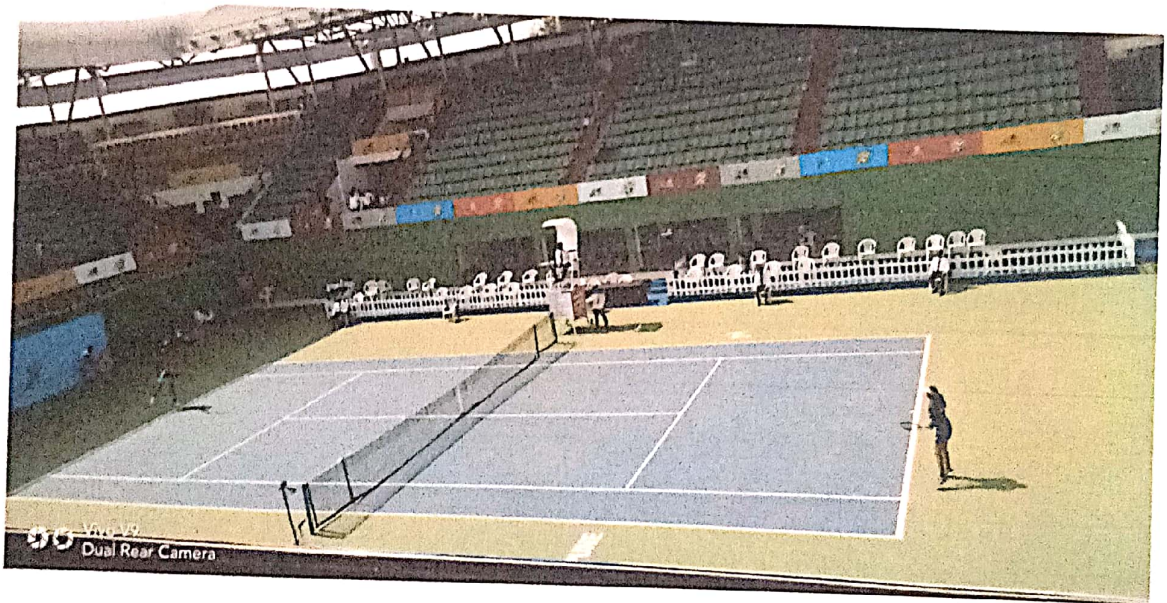
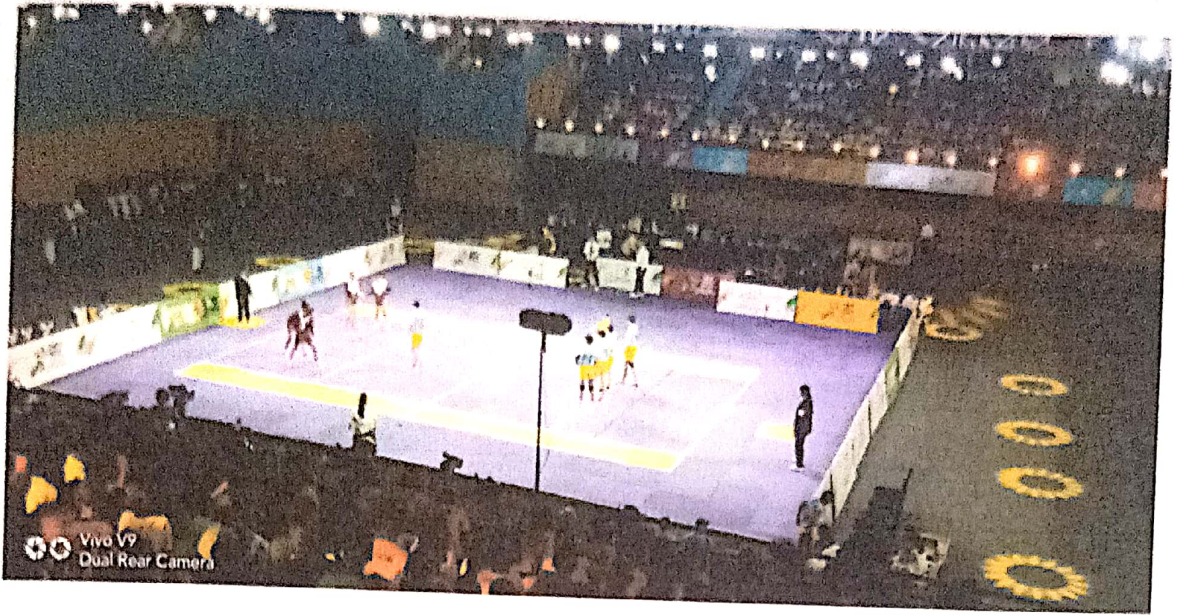



*P. R. Bhokare*

**Mr. Ritesh Bhokare**  
**Physical Director**  
**Suman Ramesh Tulsiani Technical Campus**  
**Faculty of Engineering, Khamshet, Pune**

*OR*  
*Ramesh*



### Attendance Sheet

#### SRTTC College Students List For 17/01/2019 Field Visit at Balewadi

No.	Name	Department	Attendance	No.	Name	Department	Attendance
1	Omkar Vlkari	TE Civil	P	35	Mansi Sutar	TE Mech	AA
2	Salim Mulla	TY Civil	P	36	Prashant Moghe	TE Comp	P
3	shubham Bedmutha	TE Comp	P	37	Shubham Bhandare	TY Civil	AA
4	Vishal Shinde	TE Comp	P	38	Suryakant Shinde	TY Civil	AA
5	Prasad Kadu	TE Comp	P	39	Prathmesh Dhule	TY Civil	P
6	Aniket Daunde	TY Civil	P	40	Manas Vidwans	TY Mech	AA
7	Kedar Deshpande	TE Civil	P	41	Suraj Dighe	TE Civil	AA
8	Sankaip Gade	TE Civil	P	42	Vrushab Rodge	TE Civil	P
9	Suraj Gomase	TE Civil	P	43	Sayali Bontkar	FE Comp	P
10	Shad Panare	TE Civil	P	44	Vidhi Jain	FE Civil	P
11	Dnyanshweri Shinde	TE Civil	AA	45	Gunjan Mulik	FE Comp	P
12	Suraj Game	TE Mech	P	46	Ankita More	FE Civil	P
13	Shubham Butala	TE Comp	P	47	Lavina Ruzario	FE Comp	P
14	Vidya Bagal	TE Comp	P	48	Sakshi garud	FE Comp	P
15	Neha Sawant	TE Comp	P	49	Akshay Jadhav	TE Civil	P
16	Vrushali Patil	TE Comp	P	50	Avinash Aadkar	TY Civil	P
17	Gouri salunke	TE Comp	P	51	Omkar Dalvi	TY Mech	P
18	Dipali Badgajar	TE Comp	P	52	Rajsingh Chittodiya	FE Mech	P
19	Amit Bhudesiya	TE Mech	P	53	Alankar Jangam	FE comp	P
20	Ram Wali	TE Mech	P	54	Debendu Roy	FE comp	P
21	Rasika More	TE Mech	P	55	Aditya Gosavi	SY Civil	AA
22	Pushpamala Clavan	TE Civil	P	56	Hashad Ali	TE Civil	P
23	Dhanshri sagale	TE Civil	P	57	Pratik Naik	SE Comp	P
24	Urmila Gaykhe	TE Civil	P	58	Sohail Shaikh	SE Comp	P
25	Ayush Khanolkar	TE Civil	P	59	Rohit Nanaware	FE Comp	P
26	Yash Lahure	FE Comp	P	60	Sarvesh Pawaskar	FE comp	P
27	Tejash Bhanusghare	FE Comp	P	61	Abhijeet Sahani	FE Civil	P
28	Jai Singh	SE Comp	P	62	Kapil Shitole	FE Comp	P
29	Kunal Mali	TE Civil	P	63	Pankaj Bodake	TY Civil	P
30	Viraj Shrikhnade	TE Civil	P	64	Supriya Wavse	TY Civil	P
31	Amit shrikhande	TE Civil	P	65	kanchan Bhagwat	TE Comp	P
32	Pratik Parbhane	SE Comp	AA	66	Shivangi R.M.	TE Civil	P
33	Tejas jagtap	TE Civil	P	67	Sujit Suryawanshi	TE Civil	P
34	Mehul Shah		P	68	Pratik Bharti	TE Civil	P

17/01/2019  
P.L. Kulkarni

17/01/2019  
R. R. Bhokare

Mr. Ritesh Bhokare  
Physiocal Director

Total no. of student Register	58
Total no. of Present	60
Total no. of students Absent	8





### Attendance Sheet

#### SRTTC College Students List For 17/01/2019 Field Visit at Balewadi

No.	Name	Department	Attendance	No.	Name	Department	Attendance
1	Omkar Vikari	TE Civil	P	33	Mansi Sutar	TE Mech	
2	Salim Mulla	TY Civil	P	34	Prashant Moghe	TE Comp	P
3	shubham Bedmutha	TE Comp	P	35	Shubham Bhandare	TY Civil	
4	Vishal Shinde	TE Comp	P	36	Suryakant Shinde	TY Civil	P
5	Prasad Kadu	TE Comp	P	37	Prathmesh Dhule	TY Civil	
6	Aniket Daunde	TY Civil	P	38	Manas Vidwans	TY Mech	
7	Kedar Deshpande	TE Civil	P	39	Suraj Dighe	TE Civil	
8	Sankalp Gade	TE Civil	P	40	Vrushab Rodge	TE Civil	P
9	Suraj Gomase	TE Civil	P	41	Sayali Bontkar	FE Comp	P
10	Shad Panare	TE Civil	P	42	Vidhi Jain	FE Civil	P
11	Dnyanshweri Shinde	TE Civil	P	43	Gunjan Mulik	FE Comp	P
12	Suraj Game	TE Mech	P	44	Ankita More	FE Civil	P
13	Shubham Butala	TE Comp	P	45	Lavina Ruzario	FE Comp	P
14	Vidya Bagal	TE Comp	P	46	Sakshi garud	FE Comp	P
15	Neha Sawant	TE Comp	P	47	Akshay Jadhav	TE Civil	P
16	Vrushali Patil	TE Comp	P	48	Avinash Aadkar	TY Civil	P
17	Gouri salunke	TE Comp	P	49	Omkar Dalvi	TY Mech	P
18	Dipali Badgujar	TE Comp	P	50	Rajsingh Chitrodia	FE Mech	P
19	Amit Bhudesiya	TE Mech	P	51	Alaniker Jangam	FE comp	P
20	Ram Wali	TE Mech	P	52	Debendu Roy	FE comp	P
21	Rasika More	TE Mech	P	53	Aditya Gosavi	SY Civil	
22	Pushpamala Clevan	TE Civil	P	54	Hashad Ali	TE Civil	P
23	Dhanshri segale	TE Civil	P	55	Pratik Naik	SE Comp	P
24	Urmila Gaykhe	TE Civil	P	56	Sohail Shaikh	SE Comp	P
25	AyushKhanolkar	TE Civil	P	57	Rohit Nanzware	FE Comp	P
26	Yash Lahure	FE Comp	P	58	Suresh Pawaskar	FE comp	P
27	Tejash Bhanusghare	FE Comp	P	59	Aamjeet Sarathi	FE Civil	P
28	Jai Singh	SE Comp	P	60	Kapil Shinde	FE Comp	P
29	Kunal Mali	TE Civil	P	61	Pankaj Sotake	TY Civil	P
30	Viraj Shikhnade	TE Civil	P	62	Supriya Walse	TY Civil	P
31	Amit shrikhande	TE Civil	P	63	Shubham Kulkarni	TE Comp	P
32	Pratik Parbhane	SE Comp	P	64	Shubham Kulkarni	TE Civil	P



**Suman Ramesh Tulsiani Technical Campus**

**Faculty of Engineering**

Mauje: Khamshet, Pune-Mumbai Highway(NH4), Tal:Maval, Dist: Pune- 410405

Approved By A.I.C.T.E. New Delhi, Recognized by Govt. of Maharashtra, Affiliated to University of Pune

## **Activity Report**

**Academic Year: 2018 - 2019**

**Semester: II**

**To,  
The Principal,  
SRTTC,Khamshet  
Pune – 410405**

**Date: 09/03/2019**

**Subject: Report on Exam of Physical Education &Sports 2019**

Respected Sir,

As per the norms of **Savitribai Phule Pune University** the Department of Physical Education & sports has conducted Physical Education & Sports Examination of the academic year 2018 -2019for **First Year Degree students on Friday, 8th March 2019**.The Examination was divided into The Project Work & Practical Format. **Prof.Pandurang T.Ingale** The physical director of Prathibha College of Commerce & Computer Studies, Chinchwad, Pune – 411019 was invited as an **External Examiner**.

I hereby inform you that I have attached a few Photographs of the **Practical, Attendance sheet, Results sheet**of the examination for your reference.







**Mr.RiteshBhokare**  
**Physical Director,**  
**SRTTC,Khamshet.**

सावित्रीबाई फुले पुणे विद्यापीठ  
(पूर्वीचे पुणे विद्यापीठ)



क्रीडा व शारीरिक शिक्षण मंडळ

आयुष्यमंडळ, गणेशखिंड, पुणे - ४११ ००७.

दूरध्वनी क्र. ०२०-२५५०११४७, २५५०११४२, टेलिफॅक्स ०२०-२५५९७५९९

संदर्भ: विज्ञीम/३/७६६

दिनांक: ०७ जून, २०१८.

प्रति,

मा. प्राचार्य/मा. संचालक/मा. विभागप्रमुख,  
सावित्रीबाई फुले पुणे विद्यापीठ संलग्न असलेली सर्व  
महाविद्यालये व मान्यताप्राप्त संस्था  
सावित्रीबाई फुले पुणे विद्यापीठातील सर्व पदव्युत्तर विभाग.

विषय : आंतरराष्ट्रीय योग दिनाबाबत.....

महोदय/महोदया,

उपरोक्त विषयास अनुसरून आपणांस या पत्राद्वारे कळविण्यात येते की, दि. २१ जून हा दिवस आंतरराष्ट्रीय योग दिन म्हणून गत तीन वर्षांपासून आयोजित करण्यात येत आहे.

आपणांस विनंती की गुरुवार, दि. २१ जून, २०१८ रोजी आपल्या महाविद्यालयामध्ये ४ था "आंतरराष्ट्रीय योग दिन" आयोजित करण्यात यावा. तसेच वरील आयोजित कार्यक्रमाचा अहवाल फोटोसह संचालक, क्रीडा व शारीरिक शिक्षण मंडळ, सावित्रीबाई फुले पुणे विद्यापीठ यांचेकडे दि. ३० जून, २०१८ अखेरपर्यंत पाठवावा.

कळावे,

डॉ. दिपक माने

संचालक,

क्रीडा व शारीरिक शिक्षण मंडळ,

अधिष्ठाता, आंतर-विद्याशाखीय अभ्यास विद्याशाखा



**Suman Ramesh Tulsiani Technical Campus**

**Faculty of Engineering**

Mauec: Khamshet, Pune-Mumbai Highway(NH4), Tal:Maual, Dist: Pune- 410405

Approved By A.I.C.T.E. New Delhi, Recognized by Govt. of Maharashtra, Affiliated to University of Pune



Ref-SRTTC/Stu.development/2018-19/

DATE- 19/06/2018

## **NOTICE**

This is to inform all the students and staff as you are aware that United Nations General Assembly has declared **21<sup>st</sup> June** as **World Yoga Day**. The event will be celebrated worldwide by the people of all countries by practicing Yoga.

SRTTC will also celebrate World Yoga Day on 21<sup>st</sup> June 2018, Wednesday.

**Time-** 9.30am To 10.30am

**Venue-** Central court In front of Mechanical Department

All staff and students must attend the program and inform your friends and relatives to be present for event.

Thanking you

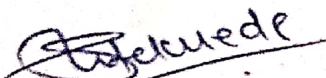
  
Prof. Ankush Patekhede

**Event Coordinator**

  
Prof. K.M.Patil

**Assot. Dean SD**

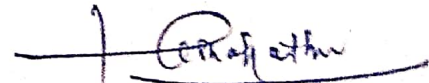
  
Dr. H.G.Phakatkar

**Principal**





**Suman Ramesh Tulsiani Technical Campus**

**Faculty of Engineering**

Mauje: Khamshet, Pune-Mumbai Highway(NH4), Tal:Maival, Dist: Pune- 410405

Approved By A.I.C.T.E. New Delhi, Recognized by Govt. of Maharashtra, Affiliated to University of Pune

## Activity Report

Academic Year: 2018 - 2019

Semester: I

To,  
Director of Sports,  
Physical Education and Sports Department  
SP Pune University,  
Pune-411007

**Subject: Report on "International Day of Yoga" held on Thursday, 21<sup>st</sup> June, 2018.**

Respected Sir,

SRTTC Kamshet has organized "International Day of Yoga" on 21<sup>st</sup> June 2018 at 9.30. It was arranged in front of Mechanical department corridors area. Welcome speech and anchoring arranged by Dr. BA. Kamalapurkar(DESH HOD). She introduced about International Day of Yoga and its importance in day today life.

International Yoga Day aims to raise awareness worldwide of the many benefits of practicing yoga. Prof. Jitendra Garud and Mr. Ritesh Bhokare (Physical Director ) both conducted Yoga demonstration. In this event 23 Faculty and 75 students actively participated. We have attached some memorable event photo here:

1. Welcome speech and anchoring arranged by Dr. BA. Kamalapurkar (DESH HOD).

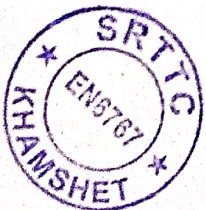
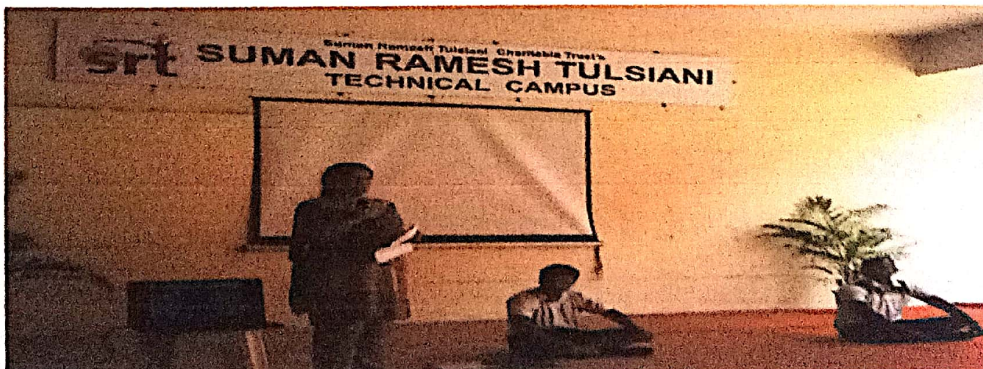

2. Prof. Jitendra Garud and Mr. Ritesh Bhokare(Physical Director ) gave guidance to all Faculty Members



3. SRT Faculty members and students Active Participation:

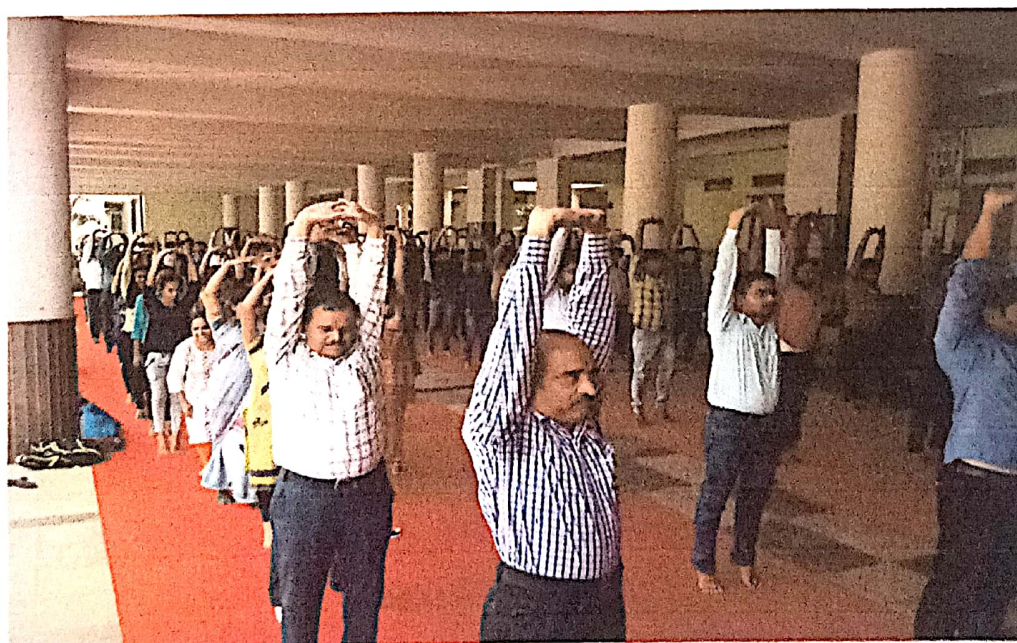

4. Students Active Participation :





**Objectives of activity**

1. To increase the health issue awareness.
2. To integrate the importance of yoga in life.
3. International Yoga Day aims to raise awareness worldwide of the many benefits of practicing yoga.

**Outcome of the Activity:**

1. Students and Faculty learnt to perform several Yogasanas.
2. Develop Physical Fitness

  
Prof. Ankush Patekhede  
Event Coordinator

  
Mr. Ritesh Bhokare  
Physical Director

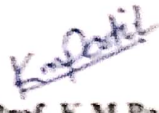
  
Prof. K.M Patil  
Assot. Dean SD

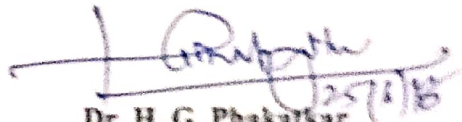
  
Dr. H. G. Phakalkar  
Principal  
SRTTC, Kamshet, Pune



## World Yoga Day Schedule

09:30Am → Assembly

09:32Am → Briefing about the program.

09:36Am → - Loosening Practices

- Neck Bending
- Trunk Movement
- Knee Movement

09:40Am → Yogāsanas

A) Standing Posture

- Tādāsana
- Vṛikṣāsana
- Pāda-Hastāsana
- Ardha Çakrāsana
- Trikoṇāsana

B) Siting Posture

- Bhadrāsana
- Ardha Uṣṭrāsana
- sasānkāsana
- Vakrāsana

C) Front laying Postures

- Bhujangāsana
- salabhāsana
- Makarāsana

D) Back laying Postures

- setubandhāsana
- Pavanamuktāsana
- savāsana

09:52Am → Kapalbhaati

09:55Am → Anlom-Vilom

09:57Am → Bhramri Pranayaam

10:00Am → Meditation

10:10Am → Shaanti Path

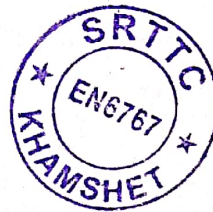

## Suman Ramesh Tulsiani Technical Campus, Pune

Date: 21<sup>st</sup> June 2019

Time: 9.30am

Agenda:- YOGA DAY

Sr No.	Name Of Member	Designation	Sign	Remark
1	Girish N Mathe	Asst prof.		
2	S.R. Ingle	Asst. Prof		
3	S A Magdum	- u -		
4	L.R. Dhumphe	Asst. Prof.		
3	C. Srinidhi	- u -		
4	S.R. Satpute	- u -		
5	S. S. Dornae	- u -		
6	Y P Bhatt	Asst. Prof.		
7	Shubham Indawat	Student		
8	Ashutosh Joglekar	Asst Prof.		
9	Pratik Naik	Student		
10	Kallesh Deve	Student		
11	Lawate Krishna	Student		
12	Shalraza. Sheikh	Student		
13	Vaibhav Kamble	student		
14	Aditya Kute	Student		
15	Raut Akshay	student		
16	Parbhane Pratik	student		
17	Sammad Desai	student		
18	Vivek S. Tiwari	Student		
19	Prasad Tumade	student		
20	Heerik Patil	student		
21	Sandya Dhese	Student		
	Ajinkya Kamble	- u -		



## Suman Ramesh Tulsiani Technical Campus, Pune

Date: 21<sup>st</sup> June 2019

Time: 9.30am

Agenda: YOGA DAY

Sr No.	Name Of Member	Designation	Sign	Remark
22	Aditya Gosani		Aditya	
23	Sainath B Yende		Sainath	
24	Jayesh S. Kamble		J.S.Kamble	
25	Rohit. N. Bansode		Rohit	
26	Yash. Shedge		Yash	
27	-Sanjay R. Ghore		Sanjay	
28	udhavi dalvi		Udhavi	
29	Ramdas More		Ram	
30	Chandh. A. Shinde		Chandh	
31	Ashutosh Jadhav		Ashu	
32	Rudhraj Passarekar		Rudhraj	
33	Avinash Pangare		Avinash	
34	Shivam S. Salunke		Shivam	
35	Akash Kulkarni		Akash	
36	Omkar Dunde		Omkar	
37	Yash Kanade		Y.K	
38	Prathmesh Bhoir		Prathmesh	
39	Manas Vidwan		Manas	
40	Sarav Kachare		Sarav K	
41	Ashish Jadhav		Ashish	
42	Manish Dalvi		Manish	
43	Abishek Kadam		Abishek	
44	Mustaqim Mulla		Mustaqim	
	Kunal Gosavi		Kunal	
	Aditya Kadam		Aditya	



## Suman Ramesh Tulsiani Technical Campus, Pune

Date: 21<sup>st</sup> June 2019

Time: 9.30am

Agenda:- YOGA DAY

Sr No.	Name Of Member	Designation	Sign	Remark
45	Skital A Patil	Asst. professor		
46	Sudip S. Dongam	—		
47	Sagar S. Ajanalkar	—		
48	Nitesh V. Dhume	—		
49	Parag Bute	—		
50	mukesh mane	—		
51	R.P. Gaikwad	—		
52	B.B. Shah	Asst. Prof		
53	Dr. B. A. Kavalyshe	Asst. Prof		
54	A.V. Kodalwad	—		
55	Yogesh Kadam	Acct Asst		
56	Amol manika	Ac Dept		
57	Ankita Awande	Student		
58	Shyali Shaurya	Student		
59	Jyoti Singh	Student		
60	Akansa Hole	Student		
61	Pooja Dalai	Student		
62	Rutuja Navawde	Student		
63	Anil Swami	Lecturer		
64	Mehul Shah	Student		
65	Suraj Gomase	Student		
66	Amit Bhadesiya	Student		
67	Sujit Suryawanshi	Student		
68	Ram wali	Student		
69	S.B. Patil	Asst. Prof		

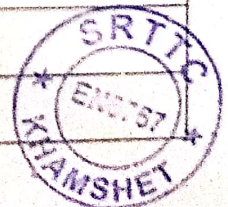



**Suman Ramesh Tulsiani Technical Campus**

**Faculty of Engineering**

Mauje: Khamshet, Pune-Mumbai Highway(NH4), Tal: Maval, Dist: Pune- 410405

Approved By A.I.C.T.E. New Delhi, Recognized by Govt. of Maharashtra, Affiliated to University of Pune

## **Activity Report**

**Academic Year:** 2018 - 2019

**Semester:** II

**To,  
The Principal,  
SRTTC, Khamshet  
Pune – 410405**

**Subject: Report on Intra Sports Event 2019**

Respected Sir,

SRTTC, Khamshet Department of Physical Education & sports has organized the intra sports 2019 for College **Diploma & Degree students** in between **from 27<sup>th</sup> feb 2019 to 1<sup>st</sup> march 2019**. Approximately **230 students** participated in outdoor & indoor sports events. Total no. of **12 sports event** has conducted in 3 days schedule. For the opening of the program Honorable trustees Mr. Shripad Kuvelkar sir & Mr. Bipin Sule sir (CEO VIT) was the chief guest. All College Faculty Member of SRTTC was present on the ground. The guest arrived at 10 am. Before the events began, the name of the event were called, the both khokho Teams were lined up. The intra sports was inaugurated by puja of new sports equipment on the ground by Dr. (Prof) Jaywant B. Sankpal (Principal SRTTC).

I hereby inform you that I have attached a few photographs, 3 days schedule sheet, Results sheet of the Events for your reference.





Some Photographs of the sports events













**Mr. Ritesh Bhokare**

Physical Director, SRTTC, Khamshet.



**Suman Ramesh Tulsiani Technical Campus**

**Faculty of Engineering**

Mauje: Khamshet, Pune-Mumbai Highway(NH4), Tal:Maal, Dist: Pune- 410405

Approved By A.I.C.T.E. New Delhi, Recognized by Govt. of Maharashtra, Affiliated to University of Pune

## Activity Report

Academic Year: 2018 - 2019

Semester: II

**Subject: Khelo India 2019 Field Visit Report of “Shree shiv chhatrapati krida sankul,Balewadi,Pune ” organized on Thursday,17th Jan, 2019.**

Respected Sir,

Department of physical Education & sports of SRTTC Khamshet had organized Khelo India 2019 Field Visit to Shree Shiv Chhatrapati Krida sankul ,Balewadi,Pune on **17<sup>th</sup> Jan 2019**. Sixty Eight (68) students were registered the Field visit from our College, out of which Sixty (60) were present on the day of visit. Students got an opportunity to witness live Basketball match, Volley ball match, Boxing, Stadium.

I hereby inform you that I have attached the Attendance Sheet of students and a few photographs for your reference. Kindly go through it.





At Balewadi stadium





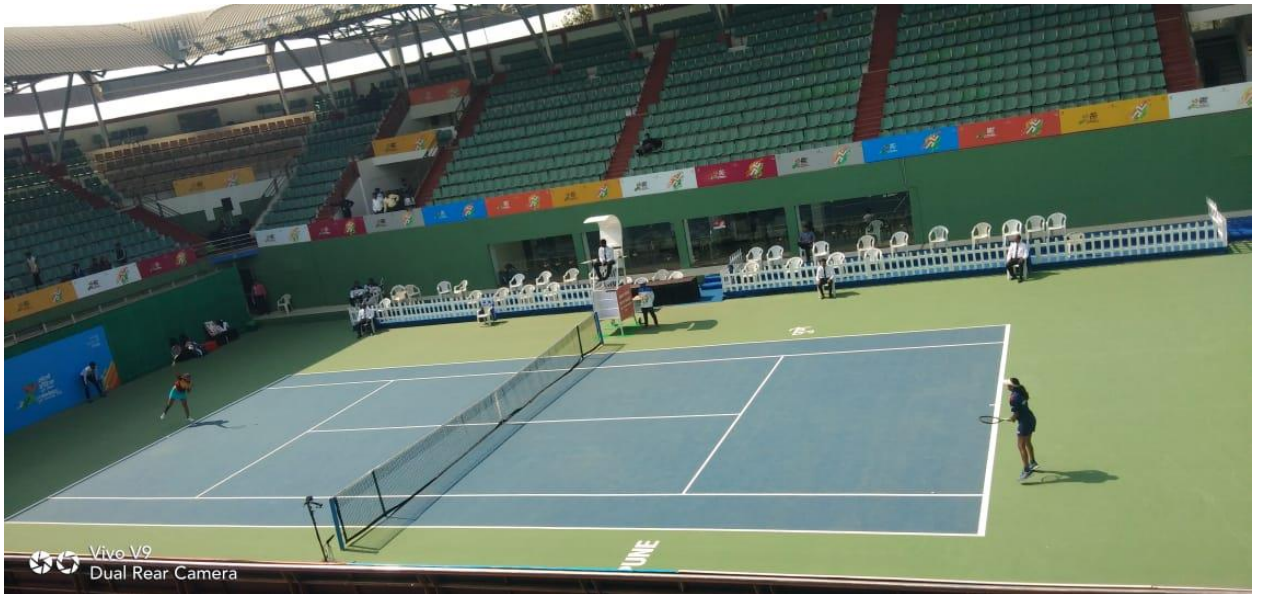



**Mr. Ritesh Bhokare**  
**Physical Director**





**Suman Ramesh Tulsiani Technical Campus**

**Faculty of Engineering**

Mauje: Khamshet, Pune-Mumbai Highway(NH4), Tal:Maival, Dist: Pune- 410405

Approved By A.I.C.T.E. New Delhi, Recognized by Govt. of Maharashtra, Affiliated to University of Pune

## Activity Report

**Academic Year:** 2018 - 2019

**Semester:** I

To,  
Director of Sports,  
Physical Education and Sports Department  
SP Pune University,  
Pune-411007

**Subject: Report on “International Day of Yoga” held on Thursday, 21<sup>st</sup> June, 2018.**

Respected Sir,

SRTTC Kamshet has organized “**International Day of Yoga**” on **21<sup>st</sup> June 2018 at 9.30**. It was arranged in front of Mechanical department corridors area. Welcome speech and anchoring arranged by Dr. BA. Kamalapurkar(DESH HOD). She introduced about International Day of Yoga and its importance in day today life.

International Yoga Day aims to raise awareness worldwide of the many benefits of practicing yoga. Prof. Jitendra Garud and Mr. Ritesh Bhokare (Physical Director ) both conducted Yoga demonstration. In this event **23 Faculty and 75 students actively** participated. We have attached some memorable event photo here:

- 1. Welcome speech and anchoring arranged by Dr. BA. Kamalapurkar (DESH HOD).**



2. **Prof. Jitendra Garud and Mr. Ritesh Bhokare(Physical Director ) gave guidance to all Faculty Members**



3. **SRT Faculty members and students Active Participation:**



#### 4. Students Active Participation :



### **Objectives of activity**

1. To increase the health issue awareness.
2. To integrate the importance of yoga in life.
3. International Yoga Day aims to raise awareness worldwide of the many benefits of practicing yoga.

### **Outcome of the Activity:**

1. Students and Faculty learnt to perform several Yogasanas.
2. Develop Physical Fitness

**Prof. Ankush Patekhede**

**Event Coordinator**

**Mr. Ritesh Bhokare**

**Physical Director**

**Prof. K.M Patil**

**Assot. Dean SD**

**Dr. H. G .Phakatkar**  
**Principal**  
**SRTTC, Kamshet,Pune**



Suman Ramesh Tulsiani Technical Campus

**Faculty of Engineering**

Mauje: Khamshet, Pune-Mumbai Highway(NH4), Tal:Maival, Dist: Pune- 410405

Approved By A.I.C.T.E. New Delhi, Recognized by Govt. of Maharashtra, Affiliated to University of Pune

## Activity Report

**Academic Year:** 2018-2019

**Semester:** II

To,

The Principal,

SRTTC FOE, Khamshet Pune

Subject: "**Sneh Suman 2k19**" held on 31<sup>st</sup> January 2019.

Respected Sir,

Every year “Sneh Suman”, an annual social gathering, which showcases considerable individual and collective talents of students is organized by SRTTC. “Sneh Suman 2k19” was held on 31<sup>st</sup> January 2019. A prayer song was sung at the beginning of the show. Prof. (Dr). J. B. Sankpal extended a warm welcome to the gathering during inaugural function.



Excellent cultural talents such as dance; drama, music etc were performed by the students. In the colorful show, students brought to limelight their creative and artistic talents.

**Event coordinator:** Prof. Sandip Deshpande

**Objectives of activity**

1. To showcase extracurricular talents of students.
2. To bring representative of students, teachers, parents etc. on common platform.

**Outcome of the Activity:**

1. Highlighting confidence and leadership qualities among students.

**Activity Coordinator  
SRTTC, Khamshet**